

the **GENERAL RADIO** **Experimenter**



© 1958 • GENERAL RADIO Company, Cambridge, Mass., U. S. A.

Since 1915 - Manufacturers of Electronic Apparatus for Science and Industry

VOLUME 32 No. 11

APRIL, 1958

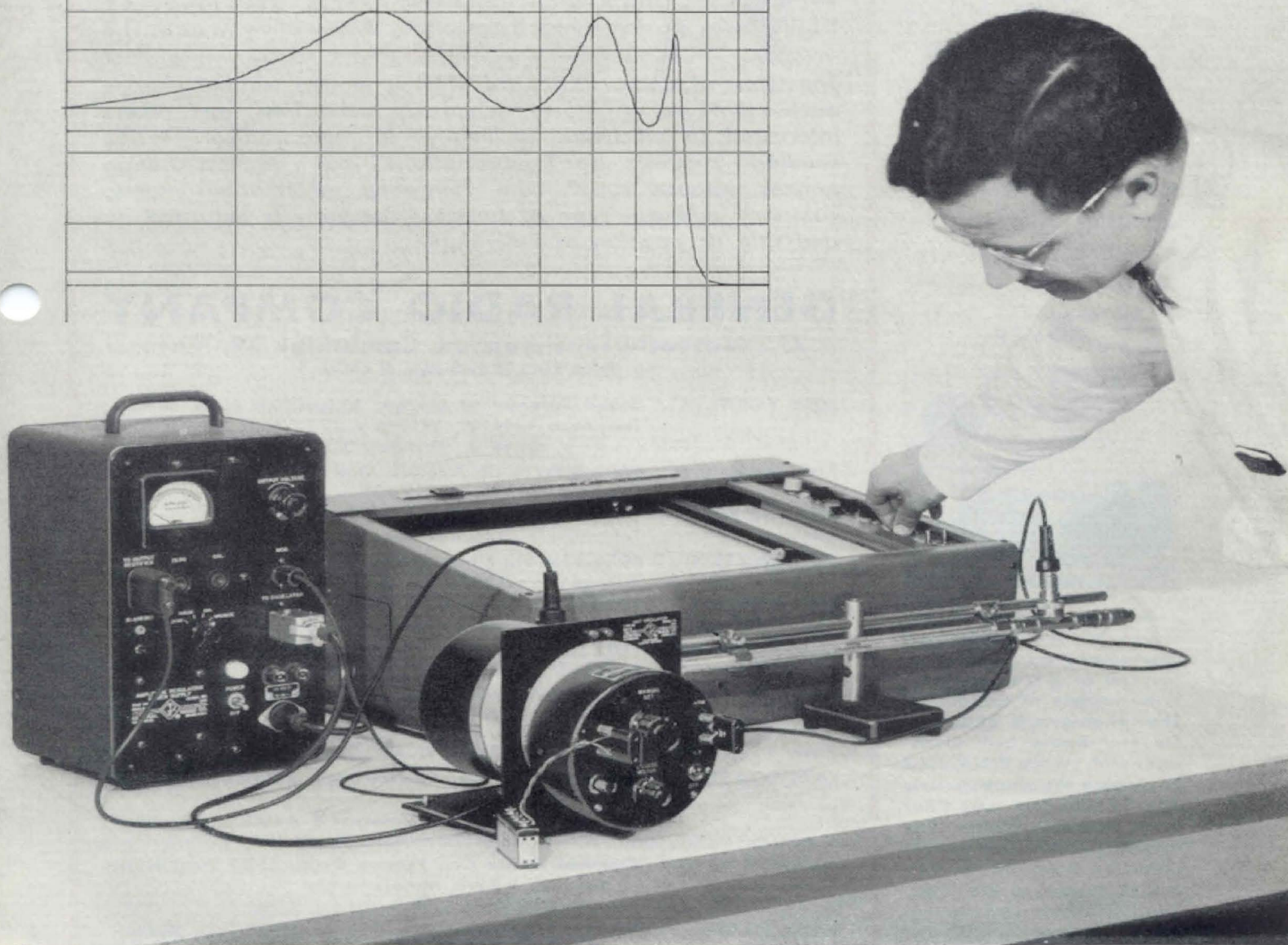
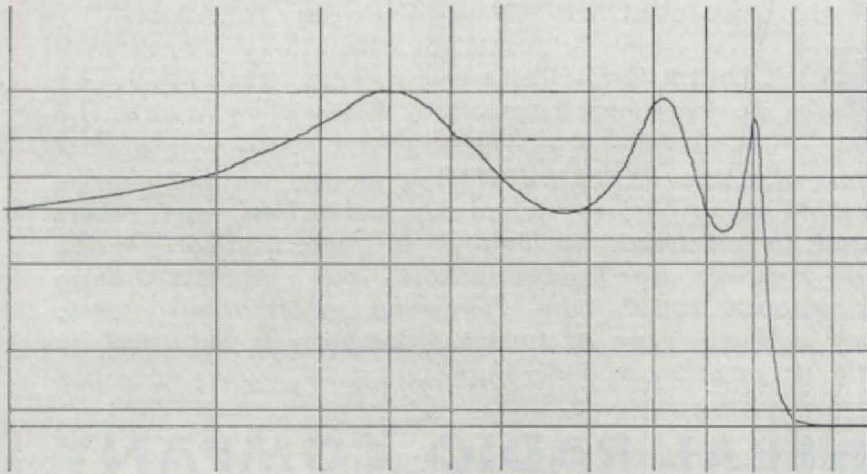

In This Issue

New Broadcast Monitors
R-C Oscillator
FCC-Approved TV Monitor

the GENERAL RADIO Experimenter



Published Monthly by the General Radio Company

VOLUME 32 • NUMBER 11

APRIL, 1958

CONTENTS

	Page
New Broadcast Monitors Add Convenience in Operation and Maintenance	3
FCC Type Approval for General Radio Television Monitors	9
Type 1210-C Unit R-C Oscillator	11
High-Power Variac® Autotransformer Assemblies	12

The General Radio EXPERIMENTER is mailed without charge each month to engineers, scientists, technicians, and others interested in electronic techniques in measurement. When sending requests for subscriptions and address-change notices, please supply the following information: name, company address, type of business company is engaged in, and title or position of individual.

GENERAL RADIO COMPANY

275 Massachusetts Avenue, Cambridge 39, Mass.

Telephone: TRowbridge 6-4400

COVER



General Radio sweep drives make possible the display of data on an oscilloscope or a recorder over wide ranges of frequency. The photograph shows a General Radio Unit Oscillator with sweep drive, used to display the characteristic of a 185-Mc low pass filter on a two-axis plotter. The resulting plot, covering frequencies from 50 to 240 Mc, is shown in the inset. The horizontal and vertical coordinate lines are drawn by the plotter pen to correspond to the calibration of oscillator frequency dial and detector output.

- NEW YORK:** Broad Avenue at Linden, Ridgefield, New Jersey
Telephone — N. Y., WOrth 4-2722
N. J., WHitney 3-3140
- CHICAGO:** 6605 West North Avenue, Oak Park, Illinois
Telephone — VillAge 8-9400
- PHILADELPHIA:** 1150 York Road, Abington, Pennsylvania
Telephone — HAncock 4-7419
- WASHINGTON:** 8055 13th St., Silver Spring, Maryland
Telephone — JUniper 5-1088
- LOS ANGELES:** 1000 North Seward St., Los Angeles 38, Calif.
Telephone — HOLLywood 9-6201
- SAN FRANCISCO:** 1182 Los Altos Ave., Los Altos, Calif.
Telephone — WHitecliff 8-8233
- CANADA:** 99 Floral Parkway, Toronto 15, Ontario
Telephone — CHerry 6-2171

REPAIR SERVICES

- EAST COAST:** General Radio Co., Service Dept., 22 Baker Avenue,
West Concord, Mass.
Telephone — Concord, EMerson 9-4400
Lincoln, CLearwater 9-8900
- MIDWEST:** General Radio Co., Service Dept., 6605 West North
Ave., Oak Park, Illinois
Telephone — VillAge 8-9400
- WEST COAST:** Western Instrument Co., 826 North Victory Boule-
vard, Burbank, Calif.
Telephone — VICToria 9-3013
- CANADA:** Bayly Engineering, Ltd., First St., Ajax, Ontario
Telephone — Toronto EMpire 8-6866



NEW BROADCAST MONITORS ADD CONVENIENCE IN OPERATION AND MAINTENANCE

The conditions of continuous operation impose requirements on broadcasting station equipment that are more specialized and more stringent than those for laboratory equipment. In the event of failure of tubes or other components, maintenance procedures must be simple and rapid, and access to circuit elements must be as easy and direct as possible. This has long been recognized by transmitter and studio-equipment manufacturers, but for many years monitoring equipment design has lagged in its recognition of these important considerations.

The General Radio TYPE 1184-A Television Station Monitor¹ was the first tangible recognition of these requirements by a test-equipment manufacturer. This modern instrument, which has been type-approved by the Federal Communications Commission,² is designed for convenient access to all parts from the front of its rack while still in operation, and it has signal-flow lines printed on its chassis and color-coded adjustments for simple and rapid trouble shooting.

These same features have now been incorporated in the new models of the TYPE 1181 Frequency Deviation Monitor and the TYPE 1931 Modulation Monitor. At the same time, the external-

¹Cady, C. A., "New Television Transmitter Monitor," *General Radio Experimenter*, Vol. 31, No. 4, September, 1956, pp. 1-10.

²See page 9.

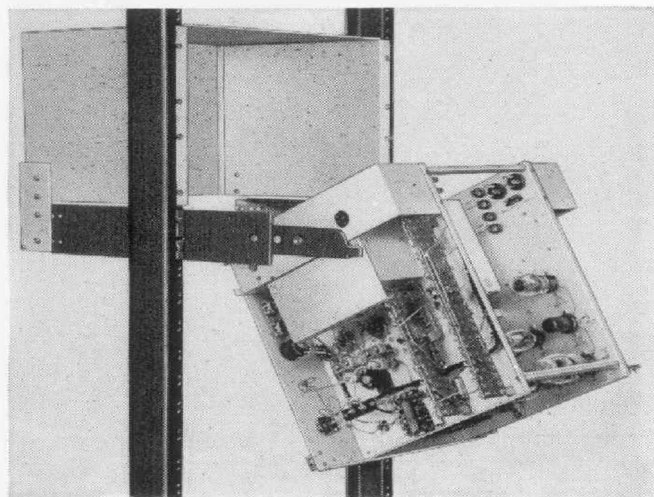
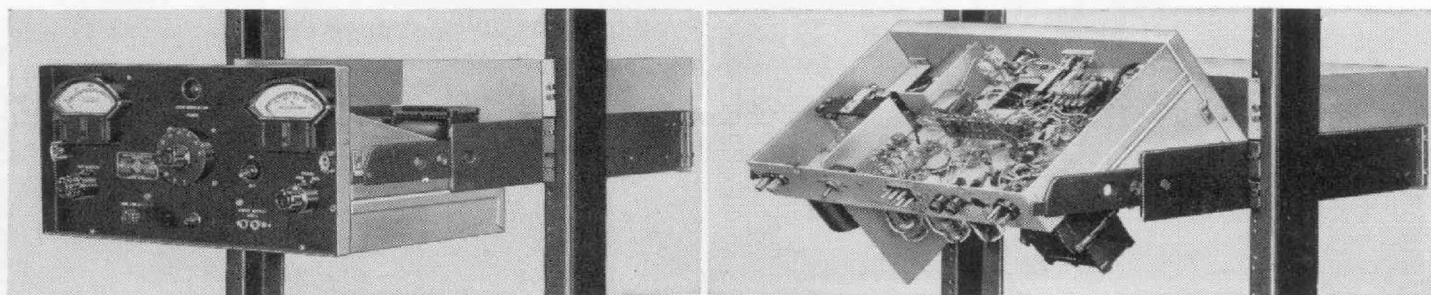

Figure 2. Type 1181-B Frequency Deviation Monitor pulled forward and tilted to give access to chassis.

meter circuits have been modified to permit the use of long telephone lines between the monitor and the external meter in remote monitoring applications.

Accessibility of chassis and components from the front of the rack is illustrated in Figure 1, which shows the TYPE 1931-B Amplitude Modulation Monitor pulled forward on its slides and then tilted to expose the underside of the chassis. The TYPE 1181-B Frequency Deviation Monitor is mounted in the same manner, as shown in Figure 2. Every operation—initial installation, operation, and maintenance—can be done from the *front* of the rack. Note that, for both instruments, as the assembly is drawn forward, the dust cover remains firmly attached to the rack. All power and other connections remain connected during these manipulations.

Figure 1. (Left) Type 1931-B Amplitude Modulation Monitor pulled forward on its slides. (Right) Tilted to expose underside of chassis.



The new circuit for external meter connections permits the external loop resistance to be as high as 5000 ohms. A switch is provided at the rear of the monitor to disconnect the external meter and connecting lines and to substitute an internal 5000-ohm resistor, in which event the monitor functions independently of external connections. This feature aids in isolating any suspected difficulties in the external circuits. The circuit is shown in Figure 3.

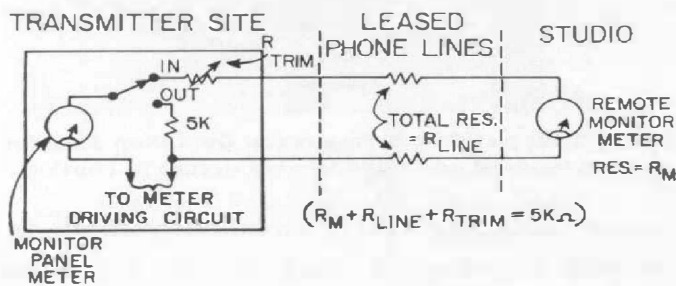

Figure 3. Circuit for external meter connections.

FREQUENCY DEVIATION MONITORS

Three models of the TYPE 1181 Frequency Deviation Monitor are now available, each designed for a specific type of service.

Type 1181-B Frequency Deviation Monitor 0.5 to 1.6 Mc

This model, which supersedes the TYPE 1181-A, is designed for use in the standard broadcast band, where, although the FCC requirements on transmitter stability are ± 20 cycles per second, transmitter frequencies must, as a practical matter, be held to a very few cycles. The crystal oscillator, temperature control, and other circuits are similar to those used in the A-model, and their stability and general reliability have been proved in over 1700 installations in all parts of the U. S. and Canada, and in countries overseas. The block diagram of Figure 4 illustrates the principle of operation.

The monitor can be used either at the transmitter site or at a location remote from the transmitter in accordance with the FCC rules permitting the unattended operation of transmitters. Remote operation up to several miles is possible with only a tuned antenna.

Type 1181-BT Color Subcarrier Monitor 3.579545 Mc

The Color Subcarrier Monitor uses circuits identical with those in the standard broadcast model, but the quartz crystal is operated at a very low oscillation amplitude in order to achieve maximum long-term stability.

In color-TV transmitters, the standard color-subcarrier-frequency signal of 3.579545 Mc is needed at any location where a color program originates, whether "live" or film. It is usually generated by an oscillator at that location, generally at or near a studio rather than at the

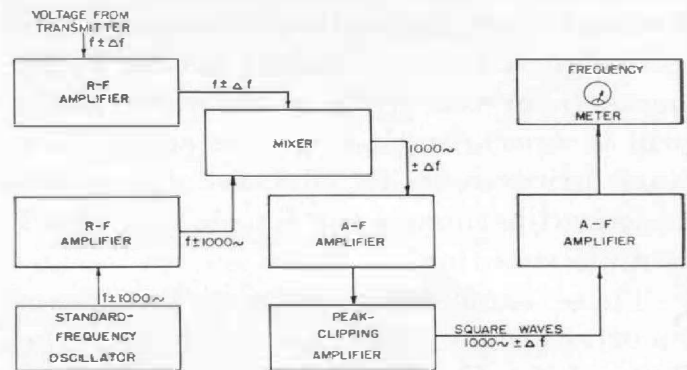

Figure 4. Block diagram of the Type 1181-B Frequency Deviation Monitor.

transmitter. Although there is no specific FCC requirement that this frequency be *monitored*, it must be held within ± 10.7 cps at all times. Good operating practice, therefore, makes continuous monitoring very desirable. The TYPE 1181-BT Color Subcarrier Monitor is ideally suited for this application. It indicates frequency deviation directly in cycles per second, and its



stability of one cycle per month or five cycles per year obviates the necessity of frequency checks against an external source, while its price is less than half that of most counter-type frequency meters.

This monitor is intended for operation at the single frequency of 3.579545 Mc only and can be used only with an unmodulated signal input.

Type 1181-BH Frequency Deviation Monitor 1.6 to 15 Mc

Identical in its circuitry and general arrangement to the TYPE 1181-B, this higher-frequency model operates in a frequency range that includes such services as aeronautical, maritime, marine, public safety, and international broadcast. While the present FCC frequency-stability requirements for these services are 30 to 50 parts per million, the use of highly selective narrow-band receivers to minimize interference requires a considerably higher degree of carrier-frequency stability. The monitor is the least expensive and most reliable means of assuring the desired carrier accuracy.

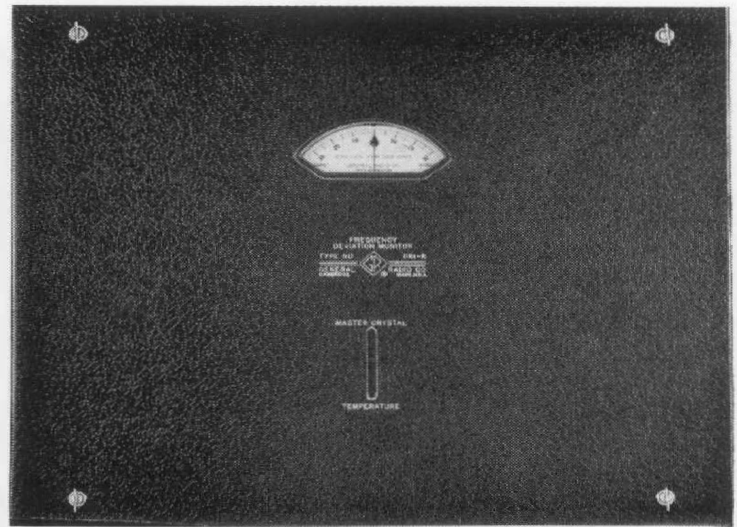

Figure 5. Panel view of the frequency deviation monitor.

General Construction

All three models are identical in construction: the TYPE 1181-B shown in Figures 5, 6, and 7 is typical. Figure 5 shows the front panel, from which all controls have been removed so that accidental misadjustment cannot occur. Only the indicators of frequency deviation and crystal temperature are visible.

The front panel is easily removed by means of the four fasteners shown in

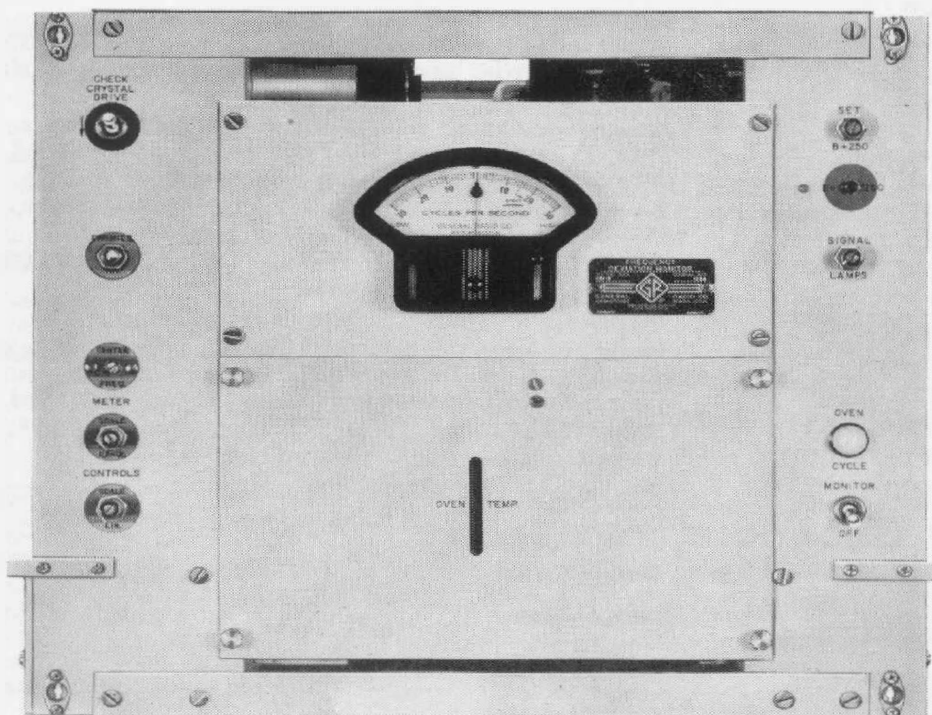

Figure 6. Monitor with dress panel removed giving access to adjustments and controls. Circles around adjustments are color coding marks.

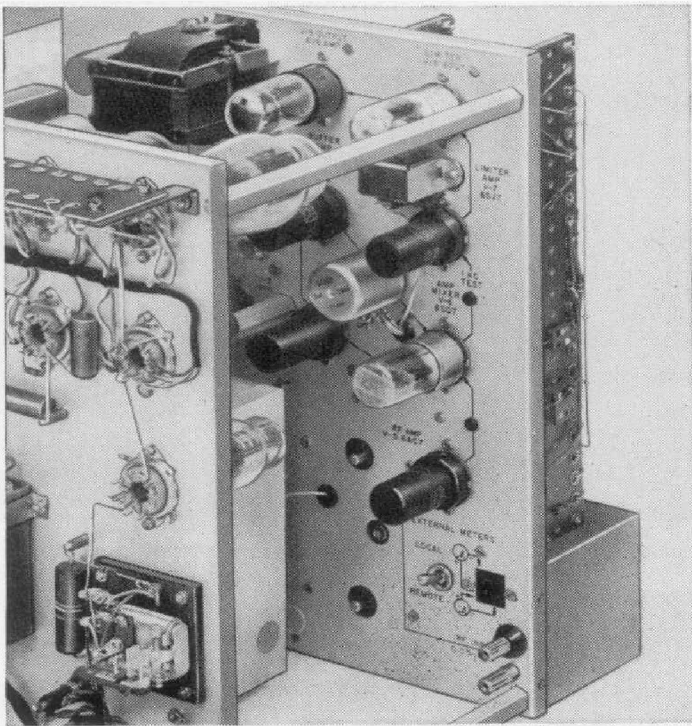

Figure 7. View of a portion of the chassis showing signal flow lines.

the corners, giving access to the adjustments and controls, as shown in Figure 6.

SPECIFICATIONS, TYPE 1181-B

Deviation Range: ± 30 cycles, readable to one cycle.

Carrier Frequency Range: 500 to 1600 kc.

Accuracy: When received, within ± 5 parts per million. An adjustment is provided to bring the reading into agreement with monitoring station measurements.

Stability: Better than one part in a million under normal operating conditions for 6 months after an initial aging period. Adjustments are provided to correct the indicated frequency in terms of standard-frequency transmissions whenever necessary.

Quartz Crystal: TYPE 376-T.

Tube Complement:

3 — 6SJ7	1 — 5V4-G
2 — 6AC7	1 — 6B4-G
2 — 6H6	1 — OC3/VR105
2 — 6SQ7-GT	1 — 2050

SPECIFICATIONS, TYPE 1181-BT

Same as for TYPE 1181-B except as specified below:

Input Frequency: 3.579545 megacycles; unmodulated.

Frequency Stability: \pm one cycle per second for 30 days; ± 5 cycles for one year.

The inside face of the removable front panel carries a block diagram and condensed operating instructions, which, together with the signal-flow lines on the chassis, make frequent reference to the instruction book unnecessary either for operation or for maintenance. A portion of this marking is shown in the rear of Figure 7. All test points are clearly labeled, and adjustments are coded red, yellow, or green, according to their degree of importance. Thus RED means "STOP — do not change this setting without first consulting instruction book." YELLOW means "CAUTION — some external equipment (voltmeter, oscilloscope) is required to set." GREEN means "GO — can easily be set without the use of external test equipment."

In addition to these features, the ultimate in convenient accessibility is provided by the pull-forward and tilt feature shown in Figure 2.

Coupling to Transmitter: A few inches of wire serving as an antenna are usually sufficient. A minimum of 50 millivolts is required into a high-impedance grid circuit.

Accessories Supplied: Quartz crystal, 2 CAP-35 Power Cords, spare fuses, and plug for connecting an external meter.

Remote Indicator: External meter for local or remote deviation indication can be connected. Maximum external loop resistance: 5 K Ω .

Power Supply: 105 to 125 (or 210 to 250 volts), 50 to 60 cycles.

Power Input: 25 watts for heater circuits, 100 watts for monitor circuits.

Mounting: 19-inch relay-rack panel.

Panel Finish: Standard General Radio black crackle. Certain standard finishes which can be processed in quantity can also be supplied.

Dimensions: Panel (length) 19 x (height) 15 $\frac{3}{4}$ inches. Depth behind panel, 13 inches.

Net Weight: 51 pounds.

Quartz Crystal: General Radio TYPE 376-R.

RF Sensitivity: .05 to 2.0 volts unmodulated r-f input.

Coupling to Transmitter: Shielded cable and plug provided.



SPECIFICATIONS, TYPE 1181-BH

Same as for 1181-B, except as noted below:

Frequency: 1.6 — 15 Mc.

Frequency Stability: ± 1 ppm for 30 days, or better; ± 5 ppm for 1 year.

R-F Input: 1.6 — 5 Mc, 0.1 — 2.5 volts, modu-

lated or unmodulated.

5 — 15 Mc, 0.4 — 3.0 volts, modulated or unmodulated.

Quartz Crystal: General Radio TYPE 376-R.

Coupling to Transmitter: Shielded cable and plug provided.

Type		Code Word	Price
1181-B	Frequency Deviation Monitor	MALAY	\$1025.00
1181-BT	Color Subcarrier Monitor	MAJOR	1025.00
1181-BH	Frequency Deviation Monitor	MADAM	1025.00

U.S. Patents 2,298,177 and 2,362,503. Licensed under patents of Radio Corporation of America and Dr. G. W. Pierce.

TYPE 1931-B AMPLITUDE MODULATION MONITOR

The TYPE 1931 Amplitude Modulation Monitor, like the TYPE 1181 Frequency Deviation Monitor, is a General Radio development and has become an industry standard. The principle of operation is shown in Figure 8. Percent modulation is indicated continuously on a panel meter, and a warning lamp glows whenever modulation percentage exceeds a level set by means of a calibrated dial.

The audio-frequency envelope of the modulation wave form is available at a pair of terminals for operating the TYPE 1932-A Distortion and Noise Meter. A 600-ohm program-monitoring output is also provided.

The front panel is shown in Figure 9. Only those controls necessary to normal operation appear on this panel, which is removable by means of the two fasteners shown. Other controls and indicators appear on the inner panel shown in Figure 10. The chassis-top view of Figure 11 shows the circuit-flow markings and the color-coded spots that identify the internal adjustments.

Constructional features of the modulation monitor are identical with those of the frequency deviation monitor and are clearly shown in Figures 1, 8, 9, and 10.

SPECIFICATIONS

Range: Modulation percentage, 0 to 110%, indicated by meter on positive peaks, 0 to 100% on negative peaks. The flashing lamp is adjustable to operate from 0 to 100% on negative peaks.

Carrier-Frequency Range: The monitor will operate at any carrier frequency from 0.5 to 60 megacycles. A single set of coils (either 0.5 to 8

megacycles or 3 to 60 megacycles) is supplied with each instrument, unless both sets are specifically ordered.

Carrier-Frequency Input Impedance: About 75 ohms in the broadcast band, increasing slightly at higher carrier frequencies and varying somewhat with input tuning.

Accuracy: The over-all accuracy of measure-

Figure 8. Functional schematic of the amplitude modulation monitor.

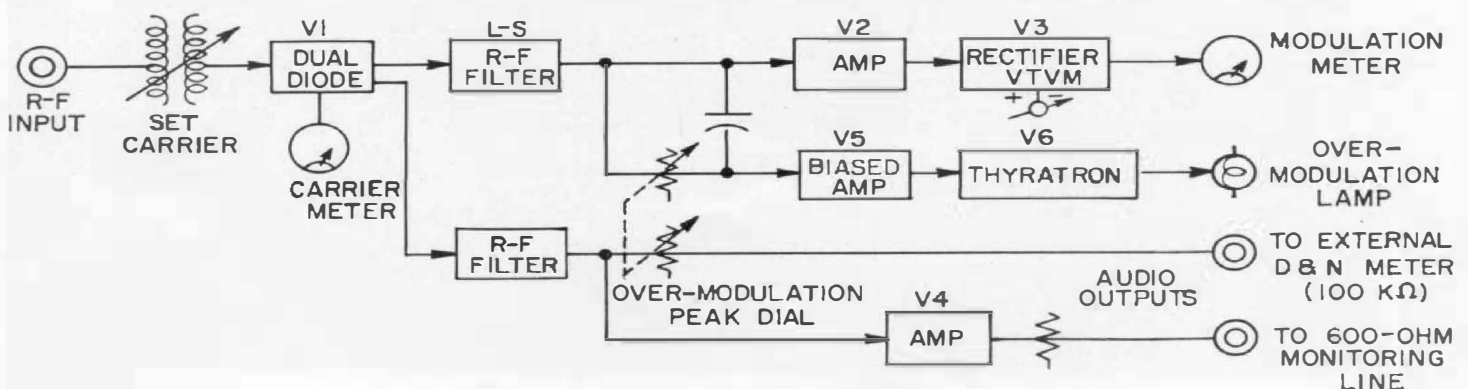

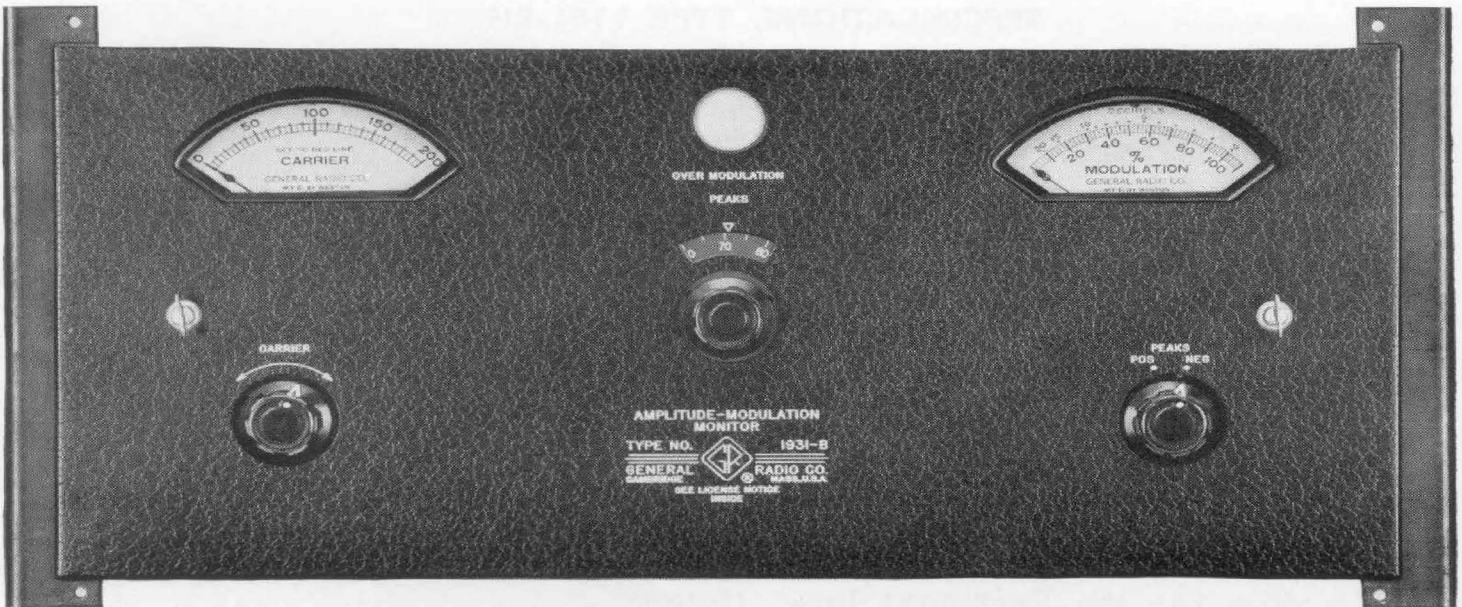

Figure 9. Panel view of the amplitude modulation monitor.

ment at 400 cycles is $\pm 2\%$ of full scale at 0% and 100%, and $\pm 4\%$ of full scale at any other modulation percentage.

Detector Linearity: The distortion in the diode detector is very low for frequencies up to 7500 cycles. Above this frequency, a small amount of negative-peak clipping occurs, reaching 5% at the extreme high end of the audio range at 15,000 cycles and 100% modulation.

R-F Power: In the broadcast range the maximum r-f power requirement is about 0.5 watt.

Tube Complement: The following tubes are used:

- | | |
|-------------|-----------|
| 2 — 6SN7-GT | 1 — 2050 |
| 2 — 6SJ7 | 2 — 0D3 |
| 1 — 6AL5 | 1 — 6X5GT |

Warning Lamp Circuit: The OVERMODULATION lamp will flash whenever the negative modulation peaks exceed the setting of the MODULATION PEAKS dial by 2% or more modulation, for audio frequencies between 30 and 7500 cycles. For higher audio frequencies,

the percentage overmodulation required to flash the lamp increases slightly.

The accuracy of the dial calibration is $\pm 2\%$ of full scale.

Meter Circuit: The response of the PERCENTAGE MODULATION meter circuit is flat, within ± 0.25 -db, between 50 and 15,000 cycles, and within ± 0.1 db between 100 and 10,000 cycles.

Either positive or negative modulation peaks may be read. Calibration in db below 100% modulation is provided.

The meter dynamic characteristic meets FCC specifications for modulation monitors.

Audio Monitoring Output: The audio output amplifier is flat, within ± 1.0 db, from 30 to 45,000 cycles. The internal impedance is 600 ohms. Distortion is less than 0.2%. Open-circuit output voltage is about 300 millivolts.

Fidelity-Measuring Output: Flat within ± 1.0 db between 30-30,000 cycles with TYPE 1392-A

Figure 10. View of monitor with outer panel removed showing adjustments and controls.

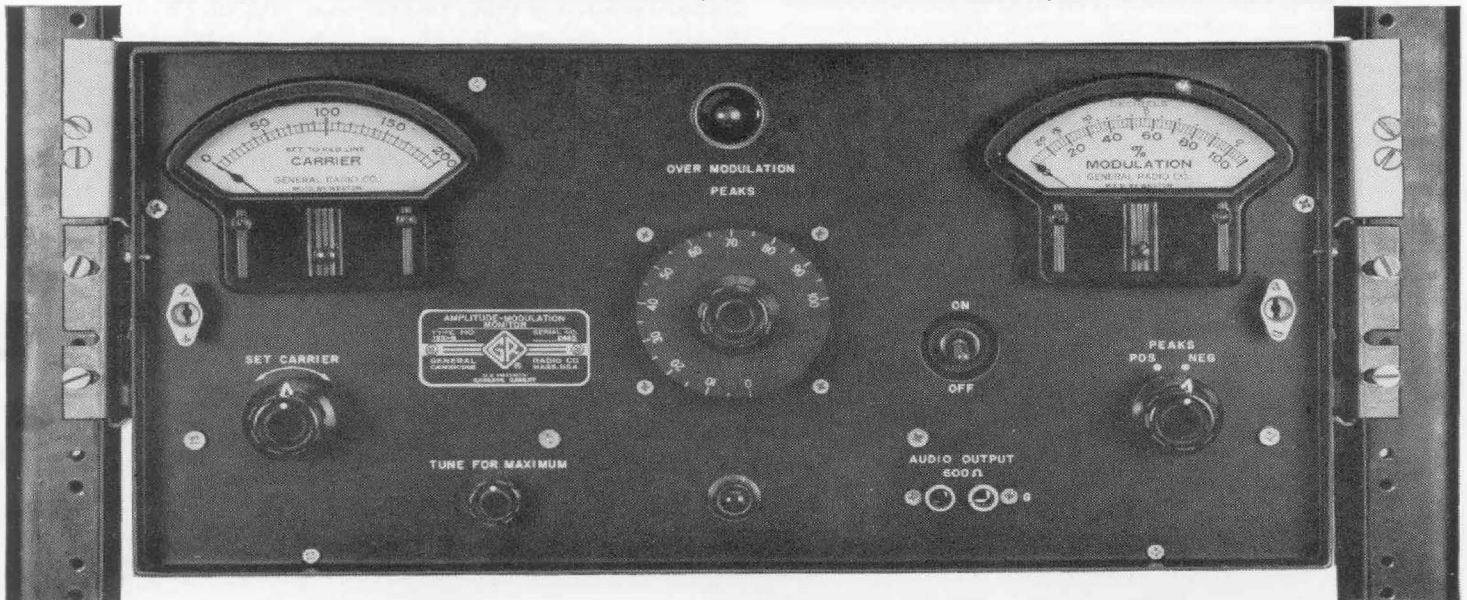
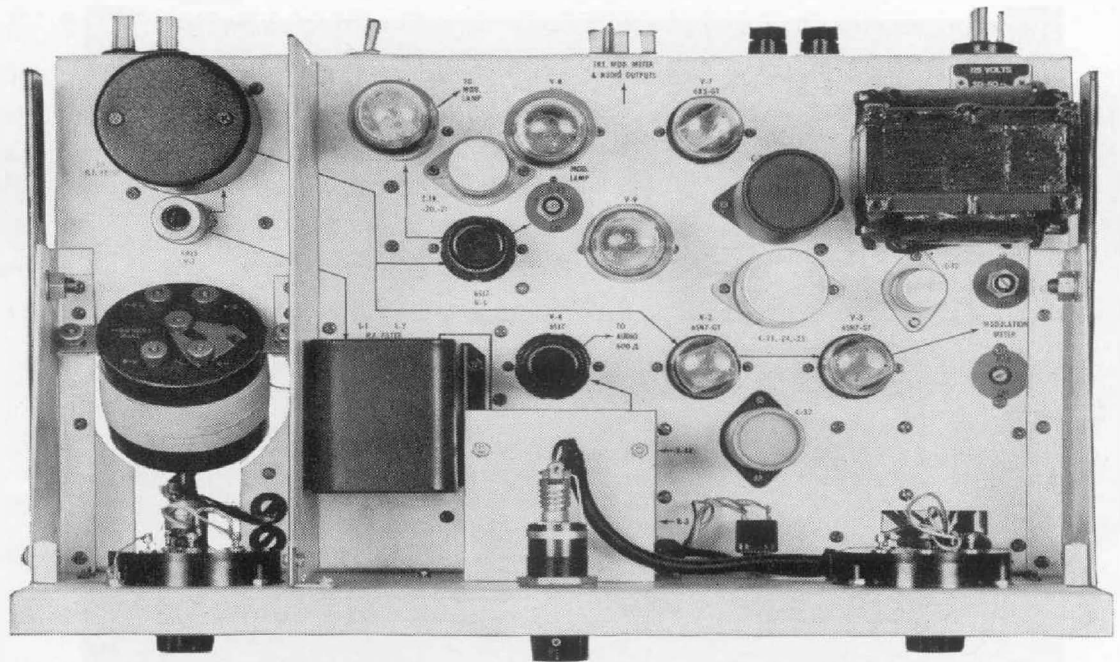



Figure 11. View of chassis showing signal flow lines.



Distortion and Noise Meter connected. Distortion less than 0.1%.

Output level varies inversely with setting of MODULATION PEAKS dial, thus providing reasonably uniform input to distortion meter at all modulation levels. Average output level, approximately 1.5 volts.

Residual noise and hum level will not exceed -80 db.

Auxiliary Output: A multipoint connector at the rear of the instrument provides a means of connecting:

1. An external Percentage Modulation Meter, either local, 800 Ω max., or remote, 5000 ohms max. loop resistance.
2. To a 600-ohm output for audio monitoring.
3. The TYPE 1932-A Distortion and Noise Meter.

Power Supply: 105 to 125 (or 210 to 250) volts, 50 to 60 cycles. Power input is approximately 50 watts.

Accessories Supplied: Multipoint connector TYPE ZCAP-5 Power Cord, spare fuses, and one set of input tuning coils (specify frequency range desired).

Mounting: The instrument is relay-rack mounted. End frames are available for table mounting. (See price list below.)

Panel Finishes: Standard General Radio black crackle. Certain standard grays which can be processed in quantity can also be supplied.

Dimensions: Panel (length) 19 x (height) 8 $\frac{3}{4}$ inches. Depth behind panel, 10 inches.

Net Weight: 32 $\frac{3}{4}$ pounds.

Type		Code Word	Price
1931-B*	Modulation Monitor, 0.5 to 8 Mc.	TARRY	\$625.00
1931-B*	Modulation Monitor, 3 to 60 Mc.	TOPIC	625.00
1931-P5	Extra Tuning Coils, 0.5 to 8 Mc.	TABBY	23.00
1931-P6	Extra Tuning Coils, 3 to 60 Mc.	TOTEM	23.00
FRI-510	End Frames.	ENDFRAMEAT	13.00 pair

*U. S. Patent 2,298,177.

FCC TYPE APPROVAL FOR GENERAL RADIO TELEVISION TRANSMITTER MONITORS

The Federal Communications Commission has issued type approval under Part 3 of the Commission's rules for the General Radio TYPE 1184-A-A Television Transmitter Monitor. The ap-

proval covers operation on all VHF and UHF channels, and the FCC type approval number is 3-105.

There are some TYPE 1184-A Monitors now in service that differ from the ap-

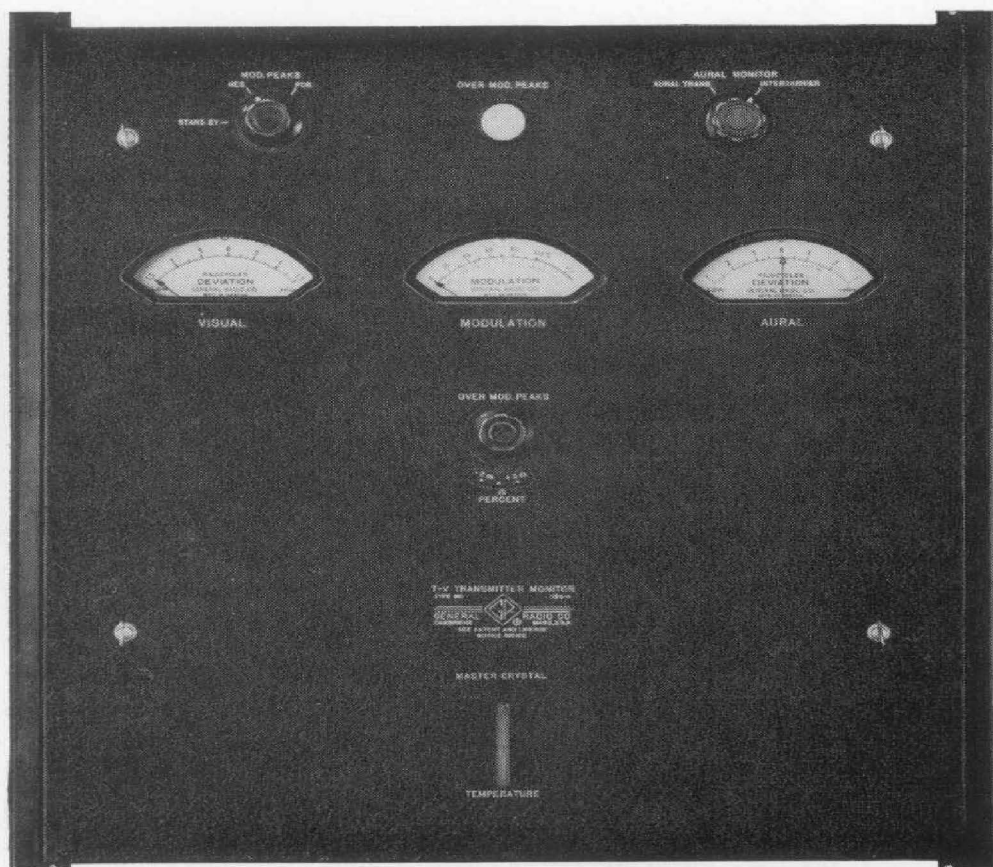

Panel view of the Type 1184-A-A Television Transmitter Monitor.

proved TYPE 1184-A-A in two minor respects, both easily changed in the field without interrupting operation. A bakelite disc in the overmodulation-warning lamp is to be removed, so as to make the light brighter, and a "Δf check" push button is to be installed in order to allow a quick check of over-all operation.

The Commission has also issued type approval for the older TYPE 1183-T-A Television Transmitter Monitor. The approval covers operation on VHF and UHF channels below 800 Mc, which covers all monitors now in service, and the FCC type approval number is 3-104.

The existing TYPES 1183-T1, -T2, and T3 Monitors now in service differ from the approved TYPE 1183-T-A in the same two respects described above for the TYPE 1184.

We will supply, on request and at no charge, instructions and all necessary material for making the changes on all TYPE 1184-A and 1183-T1, -T2, and -T3

Monitors now in service. Please write to our Service Department, 22 Baker Avenue, West Concord, Massachusetts, giving type and serial number of your monitor, shipping address, and name of individual who will be responsible for handling the matter.

These General Radio monitors are the first *complete*, television frequency and modulation monitors, and the first UHF monitors of *any* type, to be granted FCC type approval under the current rules.

The older TYPE 1183-T Monitor was designed *before* precision-offset operation, color transmission, and the current FCC rules were in effect. The fact that it has been granted approval under the current rules illustrates one of the many advantages of buying General Radio equipment. The typical substantial margin of performance *beyond* current requirements is the purchaser's best available insurance against early obsolescence.



TYPE 1210-C UNIT R-C OSCILLATOR

The Type 1210 Unit R-C Oscillator,¹ one of the electronics laboratory's most useful general-purpose instruments, has several noteworthy features:

1. Small dimensions
2. Sweepable, with inexpensive drive
3. Sine- and square-wave output
4. Low-impedance, low-distortion output
5. High-impedance, high-voltage output

This versatile oscillator appears now in slightly different external appearance, necessitated by a change in internal construction.

The new model, TYPE 1210-C, remains unchanged in its electrical characteristics but has been redesigned to use etched circuits, a development that results in a greater uniformity of performance and greater reliability than can be achieved by individual wiring.

The etched circuit, like many manufacturing developments, has been some years in achieving maturity. Fluxing, soldering, and cleaning problems have been largely solved, and its use in equip-



ment where uniformity and reliability are paramount considerations is steadily growing. For some years, the General Radio Company has been carrying on a continuous development program in etched circuit technology with the aims of (1) eliminating the "bugs" that inevitably crop up in a new process and (2) building a technique of manufacture and test.

The fruits of this program can already be seen in a number of General Radio instruments, the latest of which is the new TYPE 1210-C.

¹Bousquet, A. G., Peterson, A. P. G., and Sinclair, D. B., "Unit R-C Oscillator—20 Cycles to 500 Kc," *General Radio Experimenter*, Vol. 29, No. 12, May, 1955, pp. 1-11.

CONDENSED SPECIFICATIONS

- Frequency Range:** 20–500,000 c in 5 ranges.
- Frequency Accuracy:** ± 3%.
- Output Control:** Logarithmic, calibrated 0–50 db.
- Output System:** 3-position switch for square-wave, sine-wave low-impedance, or sine-wave high-impedance output.
- Low-Impedance Output:** (For loads of 500 ohms and higher) 0–7 v, ± 1 db up to 200 kc.
- High-Impedance Output:** (For loads of 10,000 ohms and higher) 0–45 v, ± 1 db from 200 c to 200 kc.

- Square-Wave Output:** 0–30 v peak to peak; rise time approximately $\frac{1}{4}$ μ sec.
- Tube Complement:** One each 6BQ7-A, OB2; two 12AU7's.
- Power Supply:** 6.3 v ac or dc at 1 amp.; 300 v dc at 50 ma. TYPE 1203-A Unit Power Supply for operation from 115 v, 50–60 cycles.
- Mountings:** Black-crackle finish aluminum panel and sides; aluminum cover finished in clear lacquer.
- Dimensions:** 10½ (width) x 5¾ (height) x 7 inches (depth) over-all.
- Weight:** 6¼ lb.

Type		Code Word	Price
1210-C*	Unit R-C Oscillator.....	ABAPT	\$180.00
1203-B	Unit Power Supply.....	ALIVE	40.00
480-P4U3	Relay-Rack Panel (for mounting both 1210-B and 1203-A in one panel).....	UNIPANCART	10.85

*U. S. Patent No. 2,173,427.



HIGH-POWER VARIAC® AUTOTRANSFORMER ASSEMBLIES

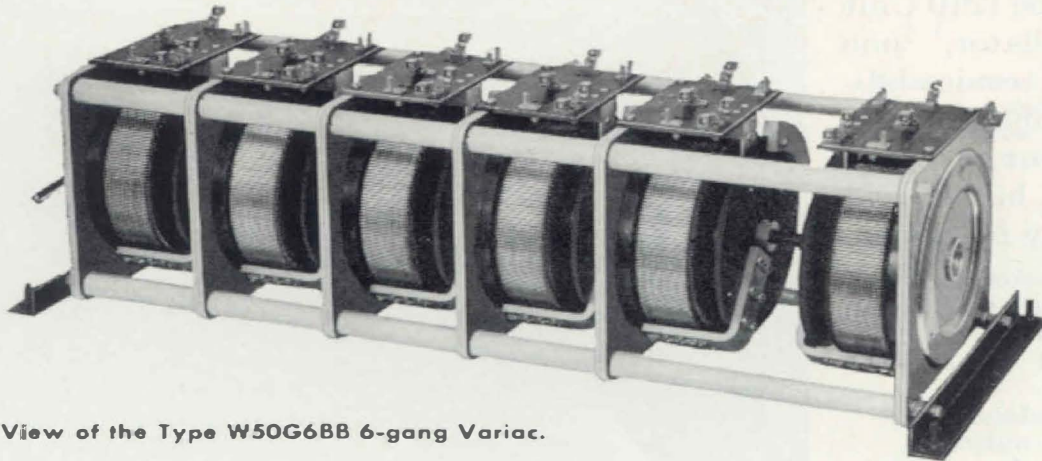

View of the Type W50G6BB 6-gang Variac.

The new W50 and W50H Variacs® are available in four-gang and six-gang assemblies as well as the familiar two-gang and three-gang assemblies available in most Variac® types. This allows double the load capacity for single assemblies. The table gives the kva ratings for 4 and 6-gang assemblies in common circuits.

All 4-, 5-, and 6-gang models are equipped with ball bearings.

it is recommended that TYPE 50-P Chokes be used with these gangs. Order chokes as follows:

Assembly	Chokes Needed
4-gang parallel.....	3 TYPE 50-P1
6-gang parallel.....	3 TYPE 50-P1 and 2 TYPE 50-P2
4-gang delta.....	2 TYPE 50-P1
6-gang delta.....	2 TYPE 50-P1 and 2 TYPE 50-P2
6-gang wye.....	3 TYPE 50-P1

CHOKES

In order to avoid circulating current,

Type	Code Word	Price
50-P1	PARALLCHOK	\$16.00
50-P2	TRIPLECHOK	16.00

Type		Load Ratings — KVA			Code Word	Price
		Parallel	Delta	Wye		
W50G4BB	4-Gang Variac	23.0	19.9		GATALGANKA	\$540.00
W50G4BBM	4-Gang Variac with case	20.7	18.0		GATALBONKA	600.00
W50G5BB	5-Gang Variac				GATALGANFO	670.00
W50G5BBM	5-Gang Variac with case				GATALBONFO	735.00
W50G6BB	6-Gang Variac	34.5	29.9	40.0	GATALGANSA	800.00
W50G6BBM	6-Gang Variac with case	31.2	27.0	36.0	GATALBONSA	870.00
W50HG4BB	4-Gang Variac	29.9	25.9		NITALGANKA	540.00
W50HG4BBM	4-Gang Variac with case	28.5	24.6		NITALBONKA	600.00
W50HG5BB	5-Gang Variac				NITALGANFO	670.00
W50HG5BBM	5-Gang Variac with case				NITALBONFO	735.00
W50HG6BB	6-Gang Variac	44.9	38.9	52.0	NITALGANSA	800.00
W50HG6BBM	6-Gang Variac with case	42.7	36.9	49.4	NITALBONSA	870.00

U. S. Patent applied for.



General Radio Company